



Beta H-SAFE

*Beta szerszám
megtartó rendszer
Height-Safe*



Beta
Height-Safe

H-SAFE *Beta szerszám megtartó rendszer*

Magasban, vagy mozgó mechanikus részek mellett végzett munkáknál a biztonság a kockázatok, a költségek és a ráfordított idő csökkentésének fontos eleme:

IDŐ MEGTAKARÍTÁS:

egy leeső szerszám megrongálódhat, vagy megrongálhat egyéb tárgyakat, ami az adott munka elvégzéséhez szükséges idő meghosszabbodásával jár.

A KÖLTSÉGEK CSÖKKENTÉSE:

egy szerszám leeseése változó mértékben befolyásolhatja a járulékos költségeket, amelyek az elvesztett szerszám újra megvásárlásától a kártérítésig terjedhetnek.

A BIZTONSÁG NÖVELÉSE:

a legfontosabb cél az emberi egészség védelme a biztonságos munkavégzés segítségével.



SZÉLENERGIA



PETROLKÉMIAI IPAR



HAJÓIPAR



NUKLEÁRIS IPAR



ÉPÍTŐIPAR



A H-SAFE megtartó rendszert a Beta üzemében tervezték, tesztelték és gyártották



A Beta H-SAFE biztonsági rendszer segítségével a szerszámok kényelmes és biztonságos módon mindig kéznél vannak

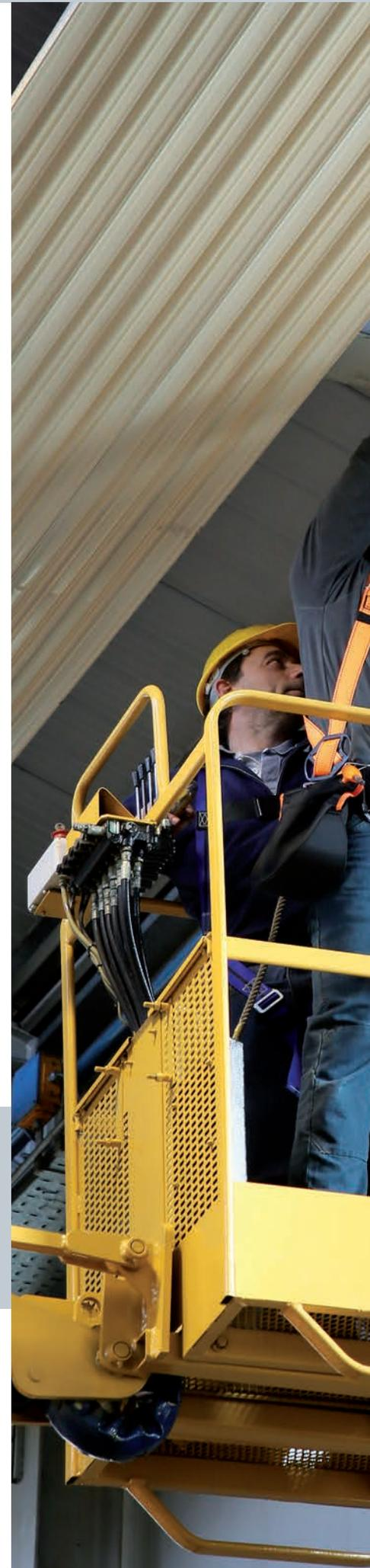



A Beta H-SAFE szerszám választék több mint 200 hivatkozást tartalmaz, ezért sikerült egy olyan sajátos megtartó rendszert tervezni, ami képes ellenállni a legszigorúbb mechanikus igénybevételeknek, ami a maximális biztonság garanciája.

Fontos a felhasználási kényelem is, ezért a kettős aktív részből álló szerszámok, mint a 42. cikkszámú csillag-villáskulcs, egy olyan huzal segítségével csatlakoznak, amely végigfuthat a szerszámtesten, míg a csavaró mozgással használt szerszámok, mint például a csavarhúzó esetében egy szabadon elforduló gyűrűvel csatlakoznak, ami megakadályozza a rögzítőhuzal felcsavarását.



A fogóknál egy furat helyezkedik el a markolaton, amiben a fogó acéljából készített mag található. A furat a markolat hátsó részére került, hogy ne akadályozza a mozgásokat, ami magasfokú kényelmet biztosít.

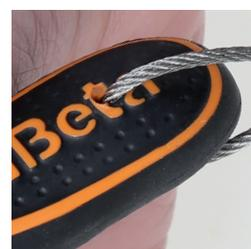

H-SAFE SZERSZÁMOK

Csillag-villáskulcs,
krómozott

UNI-ISO 7738 DIN 3113

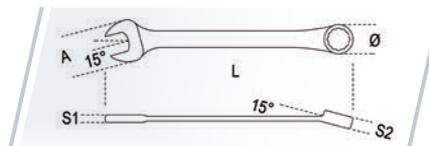

42HS

| 🔧 | mm | L mm | A mm | Ø mm | S1 mm | S2 mm | g |
|-----------|-------|------|------|------|-------|-------|-----|
| 000424006 | 6x6 | 95 | 15,2 | 10,1 | 3,4 | 5,2 | 12 |
| 000424007 | 7x7 | 105 | 17,1 | 10,8 | 3,6 | 5,7 | 16 |
| 000424008 | 8x8 | 116 | 19,0 | 12,3 | 3,9 | 6,2 | 23 |
| 000424009 | 9x9 | 127 | 20,9 | 13,7 | 4,2 | 6,7 | 27 |
| 000424010 | 10x10 | 137 | 22,8 | 15,1 | 4,5 | 7,1 | 35 |
| 000424011 | 11x11 | 148 | 24,8 | 16,5 | 4,8 | 7,5 | 44 |
| 000424012 | 12x12 | 158 | 26,9 | 18,2 | 5,1 | 7,9 | 54 |
| 000424013 | 13x13 | 169 | 28,8 | 19,6 | 5,4 | 8,4 | 66 |
| 000424014 | 14x14 | 180 | 30,8 | 21,0 | 5,7 | 8,8 | 80 |
| 000424015 | 15x15 | 190 | 32,7 | 22,4 | 6,0 | 9,2 | 90 |
| 000424016 | 16x16 | 201 | 34,6 | 23,8 | 6,3 | 9,7 | 105 |
| 000424017 | 17x17 | 212 | 36,6 | 25,2 | 6,7 | 10,2 | 120 |
| 000424018 | 18x18 | 222 | 38,5 | 26,7 | 7,0 | 10,8 | 140 |
| 000424019 | 19x19 | 233 | 40,5 | 28,0 | 7,3 | 11,4 | 160 |
| 000424020 | 20x20 | 243 | 42,5 | 29,4 | 7,6 | 11,9 | 180 |
| 000424021 | 21x21 | 254 | 44,5 | 30,7 | 7,9 | 12,4 | 205 |
| 000424022 | 22x22 | 264 | 46,4 | 32,2 | 8,1 | 12,8 | 225 |
| 000424023 | 23x23 | 275 | 48,4 | 33,5 | 8,3 | 13,2 | 255 |
| 000424024 | 24x24 | 285 | 50,3 | 34,9 | 8,5 | 13,5 | 290 |
| 000424025 | 25x25 | 296 | 52,3 | 36,2 | 8,7 | 13,8 | 310 |
| 000424026 | 26x26 | 307 | 54,3 | 37,6 | 8,9 | 14,2 | 345 |
| 000424027 | 27x27 | 317 | 56,2 | 39,0 | 9,1 | 14,6 | 375 |
| 000424028 | 28x28 | 328 | 58,2 | 40,3 | 9,3 | 15,0 | 400 |
| 000424029 | 29x29 | 338 | 60,2 | 41,9 | 9,5 | 15,3 | 450 |
| 000424030 | 30x30 | 349 | 62,1 | 43,0 | 9,7 | 15,6 | 500 |
| 000424032 | 32x32 | 370 | 66,0 | 45,7 | 10,1 | 16,2 | 565 |
| 000424034 | 34x34 | 391 | 70,0 | 48,5 | 10,5 | 16,8 | 680 |
| 000424036 | 36x36 | 412 | 73,9 | 51,3 | 10,9 | 17,5 | 825 |

42HS/AS

| 🔧 | mm | L mm | A mm | Ø mm | S1 mm | S2 mm | g |
|-----------|---------------|------|------|------|-------|-------|-----|
| 000424106 | 1/4x1/4 | 95 | 15,2 | 10,1 | 3,4 | 5,2 | 12 |
| 000424108 | 5/16x5/16 | 116 | 19,0 | 12,3 | 3,9 | 6,2 | 23 |
| 000424110 | 3/8x3/8 | 137 | 22,8 | 15,1 | 4,5 | 7,1 | 35 |
| 000424111 | 7/16x7/16 | 148 | 24,8 | 16,5 | 4,8 | 7,5 | 44 |
| 000424113 | 1/2x1/2 | 169 | 28,8 | 19,6 | 5,4 | 8,4 | 66 |
| 000424114 | 9/16x9/16 | 180 | 30,8 | 21,0 | 5,7 | 8,8 | 80 |
| 000424116 | 5/8x5/8 | 201 | 34,6 | 23,8 | 6,3 | 9,7 | 105 |
| 000424117 | 11/16x11/16 | 212 | 36,6 | 25,2 | 6,7 | 10,2 | 120 |
| 000424119 | 3/4x3/4 | 233 | 40,5 | 28,0 | 7,3 | 11,4 | 160 |
| 000424121 | 13/16x13/16 | 254 | 44,5 | 30,7 | 7,9 | 12,4 | 205 |
| 000424122 | 7/8x7/8 | 264 | 46,4 | 32,2 | 8,1 | 12,8 | 225 |
| 000424124 | 15/16x15/16 | 285 | 50,3 | 34,9 | 8,5 | 13,5 | 290 |
| 000424125 | 1x1 | 296 | 52,3 | 36,2 | 8,7 | 13,8 | 310 |
| 000424127 | 1.1/16x1.1/16 | 317 | 56,2 | 39,0 | 9,1 | 14,6 | 375 |
| 000424129 | 1.1/8x1.1/8 | 338 | 60,2 | 41,9 | 9,5 | 15,3 | 450 |
| 000424132 | 1.1/4x1.1/4 | 370 | 66,0 | 45,7 | 10,1 | 16,2 | 565 |
| 000424133 | 1.5/16x1.5/16 | 391 | 70,0 | 48,5 | 10,5 | 16,8 | 680 |

55HS

Villáskulcs, krómozott

UNI-ISO 10102 DIN 3110

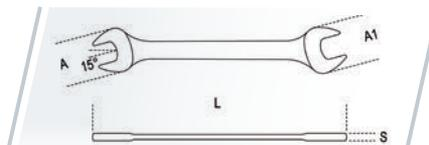

| 🔧 | mm | L mm | A mm | A1 mm | S mm | g | 🔧 | mm | L mm | A mm | A1 mm | S mm | g |
|-----------|-------|------|------|-------|------|-----|-----------|-------|------|------|-------|------|-----|
| 000554012 | 6x7 | 120 | 15,5 | 17,5 | 3,5 | 21 | 000554075 | 20x22 | 236 | 43,5 | 47,5 | 7,0 | 207 |
| 000554021 | 8x9 | 140 | 19,5 | 21,5 | 4,0 | 34 | 000554078 | 21x23 | 245 | 45,5 | 49,5 | 7,6 | 245 |
| 000554030 | 10x11 | 155 | 23,5 | 25,5 | 4,5 | 47 | 000554081 | 22x24 | 245 | 45,5 | 49,5 | 7,6 | 233 |
| 000554042 | 12x13 | 170 | 27,5 | 29,5 | 5,0 | 69 | 000554090 | 24x27 | 262 | 51,5 | 55,5 | 8,0 | 310 |
| 000554054 | 14x15 | 185 | 31,5 | 33,5 | 5,5 | 92 | 000554108 | 30x32 | 297 | 63,5 | 67,5 | 9,0 | 490 |
| 000554060 | 16x17 | 202 | 35,5 | 37,5 | 6,0 | 122 | 000554117 | 34x36 | 325 | 68,4 | 76,1 | 11,0 | 614 |
| 000554066 | 18x19 | 220 | 39,5 | 41,5 | 6,5 | 134 | | | | | | | |

142HS

Csillag-villáskulcs
irányváltós racsnival

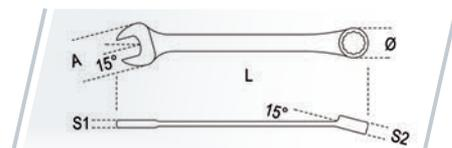

| 📄 | 📏 mm | L mm | A mm | Ø mm | S1 mm | S2 mm | 📊 g | 📄 | 📏 mm | L mm | A mm | Ø mm | S1 mm | S2 mm | 📊 g |
|-----------|---------|---------|---------|---------|----------|----------|--------|-----------|---------|---------|---------|---------|----------|----------|--------|
| 001424008 | 8x8 | 136 | 18,0 | 18,2 | 5,1 | 7,4 | 43 | 001424017 | 17x17 | 233 | 38,4 | 34,5 | 8,8 | 10,7 | 191 |
| 001424009 | 9x9 | 143 | 20,0 | 19,7 | 5,4 | 7,4 | 44 | 001424018 | 18x18 | 239 | 39,9 | 34,5 | 9,0 | 11,0 | 210 |
| 001424010 | 10x10 | 159 | 22,0 | 21,5 | 5,8 | 7,6 | 60 | 001424019 | 19x19 | 248 | 41,5 | 35,6 | 9,5 | 11,2 | 241 |
| 001424011 | 11x11 | 168 | 24,5 | 23,1 | 6,1 | 8,2 | 67 | 001424021 | 21x21 | 285 | 45,2 | 41,4 | 10,5 | 13,0 | 280 |
| 001424012 | 12x12 | 174 | 26,5 | 24,3 | 6,4 | 8,9 | 93 | 001424022 | 22x22 | 285 | 45,8 | 42,0 | 10,2 | 13,0 | 344 |
| 001424013 | 13x13 | 180 | 27,6 | 26,5 | 6,7 | 9,0 | 98 | 001424024 | 24x24 | 325 | 51,5 | 47,5 | 11,0 | 14,5 | 474 |
| 001424014 | 14x14 | 190 | 31,4 | 28,3 | 7,4 | 9,4 | 115 | 001424027 | 27x27 | 355 | 59,5 | 52,0 | 14,0 | 14,5 | 670 |
| 001424015 | 15x15 | 200 | 33,4 | 29,7 | 7,7 | 9,4 | 143 | 001424030 | 30x30 | 420 | 64,0 | 59,0 | 17,0 | 14,5 | 1000 |
| 001424016 | 16x16 | 216 | 34,6 | 32,6 | 8,1 | 9,9 | 168 | 001424032 | 32x32 | 420 | 64,0 | 59,0 | 17,0 | 14,5 | 1000 |

932HS

Tizenkétszögű pipakulcs,
fényes krómozott

NF E 74.303

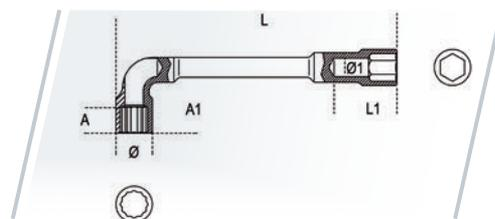
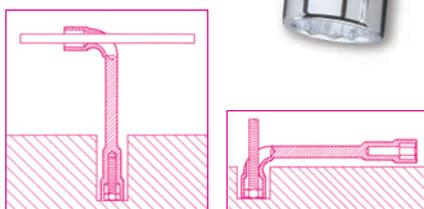

| 📄 | 📏 mm | Ø mm | L mm | Ø1 mm | A mm | A1 mm | L1 mm | 📊 g | 📄 | 📏 mm | Ø mm | L mm | Ø1 mm | A mm | A1 mm | L1 mm | 📊 g |
|-----------|---------|---------|---------|----------|---------|----------|----------|--------|-----------|---------|---------|---------|----------|---------|----------|----------|--------|
| 009324006 | 6x6 | 11,5 | 110 | 5,0 | 8,0 | 15,0 | 15,0 | 55 | 009324013 | 13x13 | 19,5 | 154 | 9,5 | 16,0 | 28,0 | 34,0 | 175 |
| 009324007 | 7x7 | 12,5 | 116 | 6,0 | 9,0 | 18,0 | 15,0 | 60 | 009324014 | 14x14 | 21,5 | 167 | 10,0 | 17,0 | 28,0 | 34,0 | 220 |
| 009324008 | 8x8 | 13,0 | 120 | 6,0 | 11,0 | 20,0 | 21,0 | 65 | 009324015 | 15x15 | 22,5 | 182 | 10,0 | 17,0 | 29,0 | 40,0 | 235 |
| 009324009 | 9x9 | 14,0 | 125 | 7,0 | 11,0 | 20,0 | 21,0 | 75 | 009324016 | 16x16 | 24,5 | 193 | 11,0 | 20,0 | 33,0 | 40,0 | 335 |
| 009324010 | 10x10 | 16,5 | 133 | 8,0 | 13,0 | 22,0 | 25,0 | 105 | 009324017 | 17x17 | 26,0 | 198 | 12,0 | 20,0 | 34,0 | 44,0 | 340 |
| 009324011 | 11x11 | 17,5 | 143 | 8,5 | 14,0 | 23,0 | 25,0 | 125 | 009324018 | 18x18 | 26,5 | 215 | 13,0 | 20,0 | 34,0 | 44,0 | 370 |
| 009324012 | 12x12 | 19,0 | 148 | 8,5 | 14,0 | 25,0 | 25,0 | 165 | 009324019 | 19x19 | 29,0 | 220 | 14,0 | 22,0 | 35,0 | 48,0 | 435 |

111HS

Állítható villáskulcs skálával, krómozott

- Állítható jobbmenetes pófák
- 22,5°-os fej mérőskálával milliméterben és collban

DIN 3117 ISO 6787

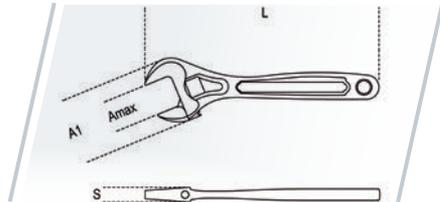

| Art. | L mm | L " | A max mm | A1 mm | S mm | g |
|-----------|------|-----|----------|-------|------|------|
| 001114020 | 200 | 8 | 28 | 62,0 | 14,0 | 325 |
| 001114025 | 250 | 10 | 34 | 70,0 | 16,0 | 505 |
| 001114030 | 300 | 12 | 35 | 84,0 | 18,0 | 790 |
| 001114038 | 380 | 15 | 45 | 97,0 | 20,0 | 1320 |
| 001114045 | 450 | 18 | 54 | 115,0 | 22,5 | 2043 |

91HS

Feltűző csillagkulcs csőtoldatok, krómozott

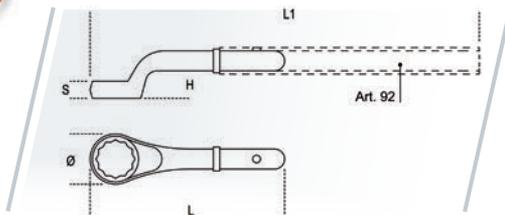

| Art. | mm | Ø mm | H mm | L mm | L1 mm | S mm | g |
|-----------|----|------|------|------|-------|------|-----|
| 000914236 | 36 | 54 | 35,5 | 245 | 735 | 20,0 | 80 |
| 000914241 | 41 | 62 | 39,5 | 265 | 750 | 22,0 | 95 |
| 000914246 | 46 | 69 | 40,0 | 280 | 910 | 23,0 | 120 |

a kiegészítők (tájoló, kulcsok és lemezek) cseréje csak a földön végezhető el! ⚠

93HS

Állványozó csillagkulcs állványcsavarokhoz, krómozott

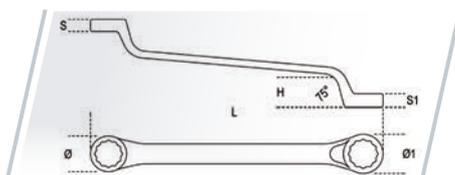

| Art. | mm | L mm | Ø mm | Ø1 mm | H mm | S mm | S1 mm | g |
|-----------|-------|------|------|-------|------|------|-------|-----|
| 000934021 | 21x22 | 310 | 35,0 | 36,0 | 32,0 | 16,0 | 16,5 | 580 |

360HS

„Stillson” csőfogó
kovácsolt acélból

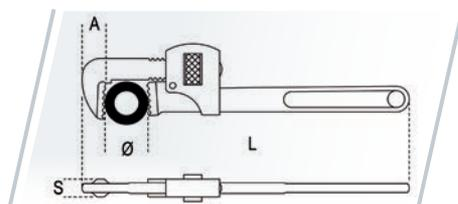

| art. | L mm | Ø max " | Ø max mm | A mm | S mm | g |
|-----------|---------|---------------|-------------|---------|---------|------|
| 003604025 | 250 | 1" gas | 34 | 22 | 16 | 520 |
| 003604035 | 350 | 1 1/2" gas | 49 | 27 | 21 | 1003 |
| 003604045 | 450 | 2" gas | 60 | 30 | 23 | 1725 |
| 003604060 | 600 | 2 1/2" gas | 76 | 38 | 27 | 2743 |

666HS

Kioldó nyomatékkulcs irányváltós
racsnival jobb oldali meghúzáshoz
meghúzási pontosság ± 3%

UNI EN 26789 ISO 6789



LC system,
kétgolyós megtartó rendszer,
a tájoló csak gombnyomásra
enged ki

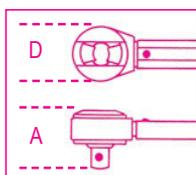

| art. | Nm | Kgfm | lbf.ft | ■ | D mm | A mm | L mm | LC system | g |
|-----------|------------|--------|--------|--------|---------|---------|---------|--------------|------|
| 006664005 | 666HS/5 | 10÷50 | 1÷5 | 7÷37 | 3/8 | 30 | 33 | 312 | 660 |
| 006664010 | 666HS/10 | 20÷100 | 2÷10 | 15÷75 | 3/8 | 30 | 33 | 381 | 730 |
| 006664021 | 666HS/20LC | 40÷200 | 4÷20 | 30÷150 | 1/2 | 40 | 43 | 470 | 1010 |
| 006664031 | 666HS/30LC | 60÷300 | 6÷30 | 50÷220 | 1/2 | 40 | 43 | 598 | 1380 |

a kiegészítők (tájolók, kulcsok és lemezek) cseréje csak a földön végezhető el !

Irányváltós racsnival

UNI-ISO 3315 DIN 3122

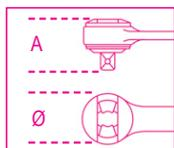

900E-HS/55



| art. | L mm | Ø mm | A mm | ■ | g |
|-----------|---------|---------|---------|-----|----|
| 009004880 | 125 | 25 | 18 | 1/4 | 90 |

910E-HS/55



| art. | L mm | Ø mm | A mm | ■ | g |
|-----------|---------|---------|---------|-----|-----|
| 009104880 | 200 | 30 | 33 | 3/8 | 238 |

920E-HS/55LC



| art. | L mm | Ø mm | A mm | ■ | LC system | g |
|-----------|---------|---------|---------|-----|--------------|-----|
| 009204860 | 275 | 40 | 43 | 1/2 | ✓ | 475 |

a kiegészítők (tájolók, kulcsok és lemezek) cseréje csak a földön végezhető el !

H-SAFE SZERSZÁMOK

T-szárú imbuszkulcs,
műanyag markolattal

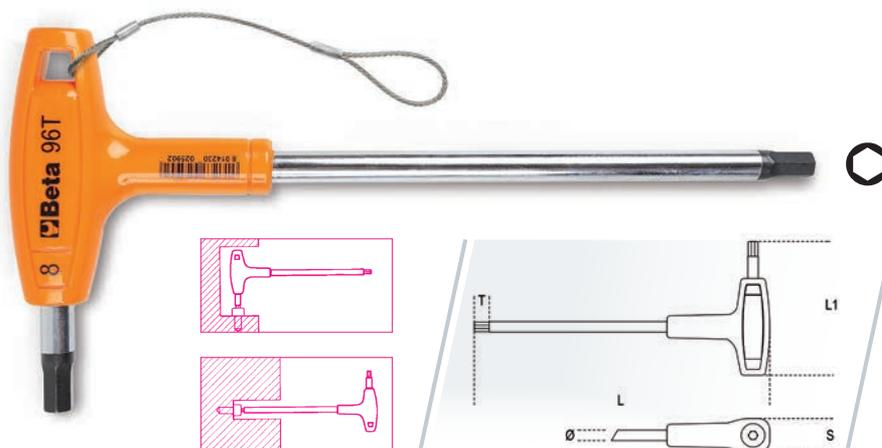

96THS

| 🔧 | mm | L mm | L1 mm | Ø mm | T mm | S mm | 📏 g |
|-----------|-----|------|-------|------|------|------|-----|
| 000964935 | 2,5 | 153 | 55 | 4 | 8,0 | 13,4 | 21 |
| 000964936 | 3 | 153 | 55 | 4 | 8,5 | 13,4 | 21 |
| 000964938 | 4 | 179 | 70 | 5 | 10,0 | 17,8 | 40 |
| 000964940 | 5 | 200 | 84 | 6 | 11,0 | 22 | 70 |
| 000964941 | 6 | 221 | 103 | 7 | 12,0 | 24 | 97 |
| 000964943 | 8 | 255 | 117 | 10 | 14,0 | 26 | 215 |
| 000964945 | 10 | 285 | 132 | 12 | 16,0 | 29 | 338 |

96THS-AS

| 🔧 | " | L mm | L1 mm | Ø mm | T mm | S mm | 📏 g |
|-----------|------|------|-------|------|------|------|-----|
| 000964673 | 5/32 | 200 | 84 | 6 | 10,5 | 22 | 70 |
| 000964674 | 3/16 | 200 | 84 | 6 | 11,0 | 22 | 71 |
| 000964675 | 7/32 | 221 | 103 | 7 | 12,0 | 24 | 103 |
| 000964676 | 1/4 | 236 | 106 | 8 | 13,0 | 26 | 141 |
| 000964678 | 5/16 | 255 | 117 | 10 | 14,0 | 26 | 210 |
| 000964680 | 3/8 | 285 | 132 | 12 | 16,0 | 29 | 336 |

97TTX-HS

T-szárú Torx®-imbuszkulcs,
műanyag markolattal,
krómzott, fekete hegyek

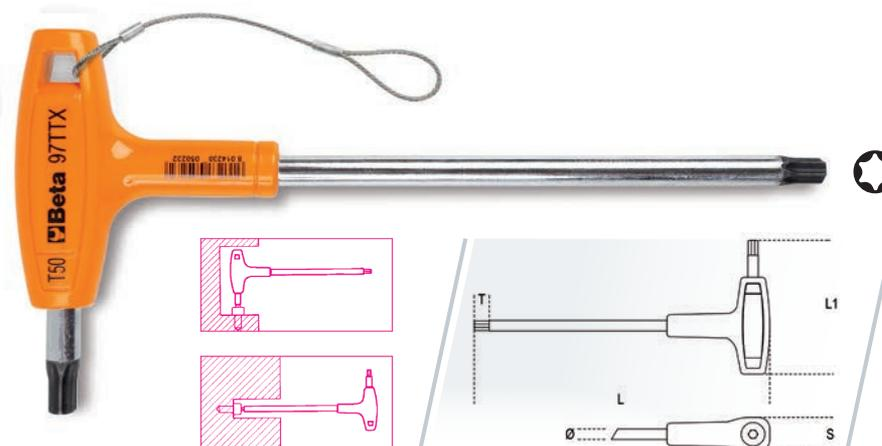

| 🔧 | ⊙ | L mm | L1 mm | S mm | 📏 g | 🔧 | ⊙ | L mm | L1 mm | S mm | 📏 g |
|-----------|-----|------|-------|------|-----|-----------|-----|------|-------|------|-----|
| 000974710 | T10 | 179 | 70 | 13 | 18 | 000974730 | T30 | 200 | 84 | 22 | 64 |
| 000974715 | T15 | 179 | 70 | 13 | 21 | 000974740 | T40 | 221 | 103 | 24 | 104 |
| 000974720 | T20 | 179 | 70 | 18 | 36 | 000974745 | T45 | 236 | 106 | 26 | 170 |
| 000974725 | T25 | 179 | 70 | 18 | 42 | 000974750 | T50 | 255 | 117 | 26 | 215 |



1290HS

Csavarhúzó hasítottfejű csavarokhoz

ISO 2380

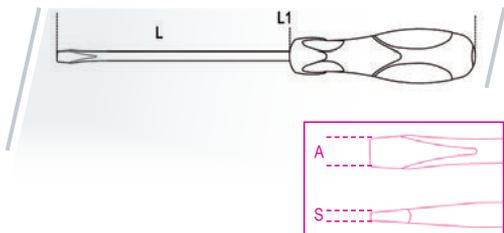

| Modell | SxAxL mm | L1 mm | g | Modell | SxAxL mm | L1 mm | g |
|-----------|-------------|-------|------|-----------|-------------|-------|-------|
| 012904006 | 0,4x2,5x75 | 171 | 33,6 | 012904042 | 1x5,5x150 | 259 | 70,4 |
| 012904012 | 0,5x3x100 | 196 | 36,8 | 012904051 | 1,2x6,5x150 | 270 | 97,8 |
| 012904021 | 0,6x3,5x100 | 196 | 39,4 | 012904057 | 1,2x8x150 | 282 | 132,0 |
| 012904030 | 0,8x4x100 | 196 | 42,4 | 012904066 | 1,6x10x200 | 332 | 168,3 |
| 012904036 | 0,8x4x150 | 246 | 47,1 | | | | |

1292HS

Csavarhúzó Phillips®-csavarokhoz

UNI/ISO 8764

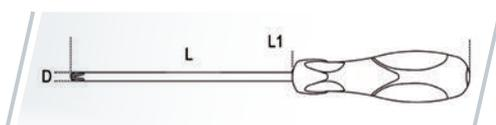

| Modell | PHxDxL mm | L1 mm | g | Modell | PHxDxL mm | L1 mm | g |
|-----------|-----------|-------|------|-----------|-----------|-------|-------|
| 012924006 | 0x3x100 | 196 | 36,6 | 012924021 | 2x6x150 | 270 | 98,3 |
| 012924012 | 1x4,5x120 | 229 | 61,7 | 012924024 | 3x8x150 | 282 | 148,3 |

1294HS

Csavarhúzó hernyócsavarokhoz

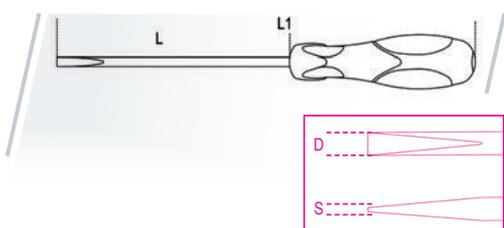

| Modell | SxDxL mm | L1 mm | g | Modell | PHxDxL mm | L1 mm | g |
|-----------|------------|-------|------|-----------|-----------|-------|------|
| 012944003 | 0,5x2,5x60 | 156 | 33,0 | 012944012 | 0,8x4x100 | 196 | 42,2 |
| 012944006 | 0,6x3x75 | 171 | 35,4 | 012944018 | 1x5x125 | 234 | 66,6 |

1299HS

Csavarhúzó Pozidriv®- és Supadriv®-csavarokhoz

UNI/ISO 8764

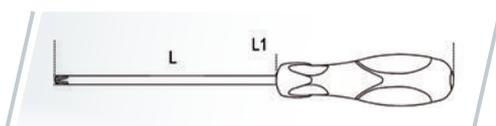

| Modell | PZ | L mm | L1 mm | g | Modell | PZ | L mm | L1 mm | g |
|-----------|----|------|-------|------|-----------|----|------|-------|-------|
| 012994000 | 0 | 60 | 156 | 35,0 | 012994006 | 2 | 100 | 220 | 88,4 |
| 012994003 | 1 | 80 | 189 | 57,2 | 012994009 | 3 | 150 | 282 | 149,0 |

1032HS

Egyenes belső Seeger-fogó, barnított, PVC-bevonattal

UNI 7914 DIN 5256

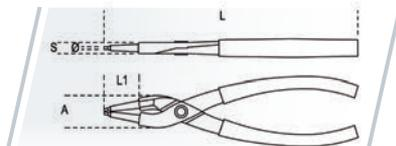

| | L mm | ∅ mm | ∅1 mm | A mm | S mm | L1 mm | g |
|-----------|---------|---------|----------|---------|---------|----------|-----|
| 010324014 | 140x1,3 | 12÷25 | 1,3 | 20 | 9,0 | 20 | 100 |
| 010324017 | 180 | 19÷60 | 1,9 | 21 | 10,0 | 24 | 150 |

1034HS

90°-os hajlított belső Seeger-fogó, barnított, PVC-bevonattal

UNI 7914 DIN 5256

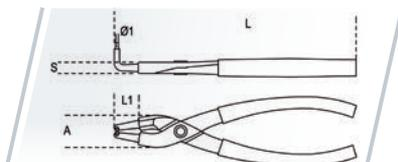

| | L mm | ∅ mm | ∅1 mm | A mm | S mm | L1 mm | g |
|-----------|---------|---------|----------|---------|---------|----------|-----|
| 010344017 | 170 | 19÷60 | 1,9 | 21 | 10,0 | 15 | 150 |

1036HS

Egyenes külső Seeger-fogó, barnított, PVC-bevonattal

UNI 7915 DIN 5254

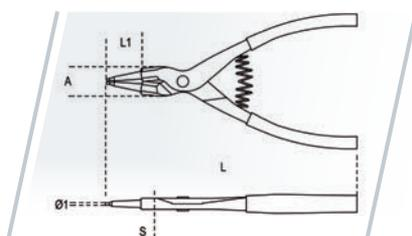

| | L mm | ∅ mm | ∅1 mm | A mm | S mm | L1 mm | g |
|-----------|---------|---------|----------|---------|---------|----------|-----|
| 010364014 | 140x1,3 | 10÷25 | 1,3 | 20 | 9,0 | 20 | 100 |
| 010364017 | 175 | 19÷60 | 1,9 | 21 | 10,0 | 25 | 160 |

1038HS

90°-os hajlított külső Seeger-fogó, barnított, PVC-bevonattal

UNI 7915 DIN 5254

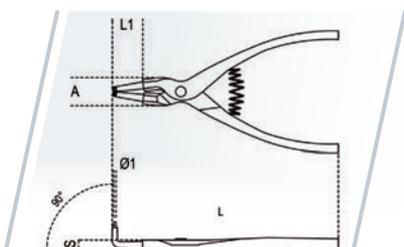

| | L mm | ∅ mm | ∅1 mm | A mm | S mm | L1 mm | g |
|-----------|---------|---------|----------|---------|---------|----------|-----|
| 010384017 | 175 | 19÷60 | - | 21 | 10,0 | 23 | 160 |

1048BM-HS

Vízpumpafogó,
villás, bimateriál nyél

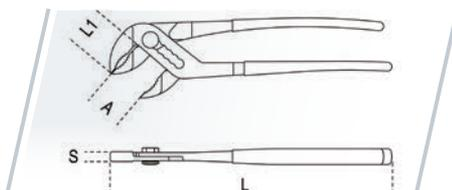

| | L mm | A max mm | L1 mm | S mm | g |
|-----------|---------|-------------|----------|---------|-----|
| 010484215 | 250 | 48 | 39 | 6,8 | 460 |

1052HS

Állítható önzáró fogó,
homorú pofájú, krómozott

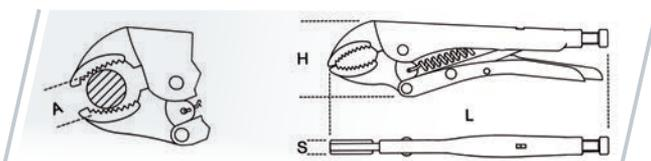

| | L mm | A mm | A1 max mm | S mm | g |
|-----------|---------|---------|--------------|---------|-----|
| 010524024 | 240 | 72 | 42 | 6,8 | 460 |

1082BM-HS

Oldalcsípőfogó, krómozott,
gumibetétes műanyag nyéllel

UNI/ISO 5749

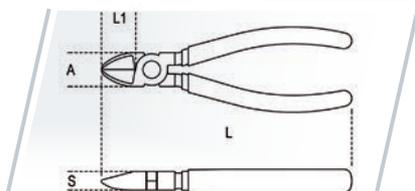

| | L mm | L1 mm | mm | A mm | S mm | g |
|-----------|---------|----------|-----|---------|---------|-----|
| 010824036 | 160 | 22 | 1,6 | 28 | 12 | 215 |

1088BM-HS

Erősített homlokcsípőfogó,
krómozott, gumibetétes
műanyag nyéllel

UNI/ISO 5748

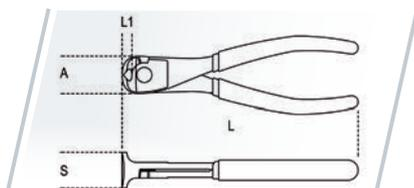

| Modell | L mm | L1 mm | mm | A mm | S mm | g |
|-----------|------|-------|-----|------|------|-----|
| 010884036 | 160 | 9 | 1,6 | 28 | 11 | 230 |
| 010884040 | 200 | 11 | 2,0 | 36 | 13 | 370 |

1128BAX-HS

Kettős hatású villanszerelő olló,
lépcsős profil, rozsdamentes acél,
DLC bevonat

- Kettős hatású vágás
- DLC bevonat: Nagy felületi keménység a pengénél (nagy kopásállóság és időtálló pengeélesség)
- Lépcsős profil: 13 és 24 mm közötti furatok tágítására létrehozva műanyagokon



| Modell | L mm | L1 mm | mm ² | g |
|-----------|------|-------|-----------------|-----|
| 011284088 | 150 | 50 | 50 | 200 |

1132BM-HS

Kábelvágó, krómozott,
gumibetétes műanyag nyéllel

UNI 8791

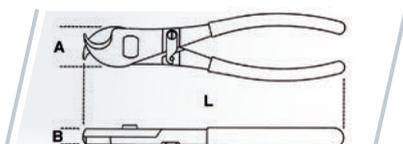

| Modell | L mm | mm | mm ² | A mm | B mm | g |
|-----------|------|----|-----------------|------|------|-----|
| 011324143 | 230 | 18 | 95 | 37 | 12,5 | 394 |

1150BM-HS

Kombinált fogó, krómozott, polírozott, gumibetétes műanyag nyéllel

ISO 5746

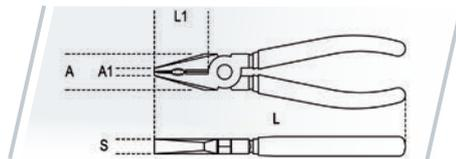

|  | L mm | L1 mm |  | A mm | A1 mm | S mm |  |
|---|---------|----------|---|---------|----------|---------|---|
| 011504036 | 160 | 37 | 1,6 | 24 | 6,3 | 11 | 200 |
| 011504038 | 180 | 41 | 1,8 | 28 | 7,1 | 11 | 275 |
| 011504040 | 200 | 45 | 2,0 | 32 | 8,0 | 14 | 310 |

1166BM-HS

Egyenes extra hosszú félkerekcsőrű fogó, krómozott, gumibetétes műanyag szárral

ISO 5745

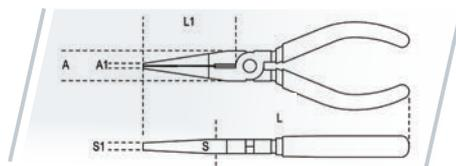

|  | L mm | L1 mm |  | A mm | A1 mm | S mm | S1 mm |  |
|---|---------|----------|---|---------|----------|---------|----------|---|
| 011664040 | 200 | 76 | 1,6 | 22,0 | 5,0 | 11,0 | 4,0 | 200 |

1168BM-HS

Hajlított extra hosszú félkerekcsőrű fogó, krómozott, gumibetétes műanyag szárral

ISO 5745

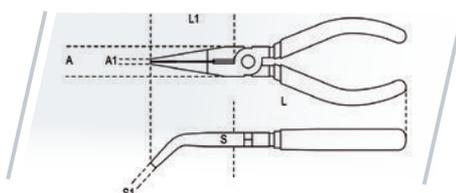

|  | L mm | L1 mm |  | A mm | A1 mm | S mm | S1 mm |  |
|---|---------|----------|---|---------|----------|---------|----------|---|
| 011684040 | 200 | 70 | 1,6 | 22,0 | 5,0 | 11,0 | 4,0 | 210 |

35HS

Erősített laposvágó,
krómozott

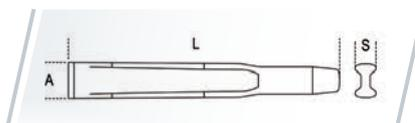

| | L mm | A mm | S mm | g |
|-----------|---------|---------|---------|-----|
| 000354004 | 200 | 23,0 | 14 | 296 |
| 000354005 | 250 | 28,5 | 15,5 | 490 |

1370FT-HS

Lakatos kalapács, francia
modell, műanyag nyéllel

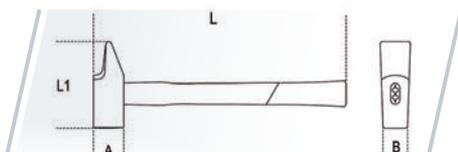

| | A mm | L mm | L1 mm | B mm | g |
|-----------|---------|---------|----------|---------|-----|
| 013704528 | 28 | 280 | 86 | 22 | 530 |
| 013704530 | 32 | 280 | 92 | 24 | 625 |
| 013704536 | 36 | 300 | 104 | 29 | 930 |

1370T-HS

Lakatos kalapács német
modell műanyag nyéllel

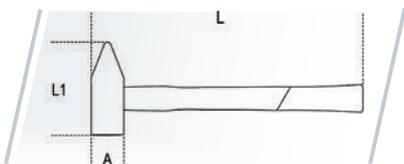

| | g | A mm | L mm | L1 mm | g |
|-----------|------|---------|---------|----------|------|
| 013704630 | 300 | 23 | 300 | 105 | 452 |
| 013704650 | 500 | 27 | 320 | 118 | 663 |
| 013704700 | 1000 | 36 | 360 | 135 | 1279 |

1390HS

Műanyag kalapács,
cserélhető végekkel,
fanyéllel

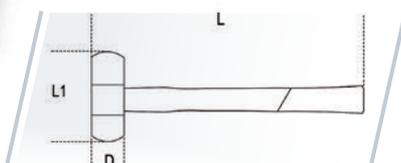

| | D mm | L mm | L1 mm | g |
|-----------|---------|---------|----------|-----|
| 013904035 | 35 | 310 | 95 | 365 |
| 013904045 | 45 | 320 | 107 | 698 |

1392HS

Ütéselnyelő műanyag kalapács, cserélhető végekkel, acélnyéllel

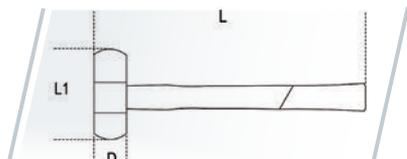

| Modell | D mm | L mm | L1 mm | g | Modell | D mm | L mm | L1 mm | g |
|-----------|------|------|-------|-----|-----------|------|------|-------|------|
| 013924035 | 35 | 305 | 115 | 670 | 013924050 | 50 | 325 | 135 | 1206 |
| 013924040 | 40 | 310 | 125 | 796 | 013924060 | 60 | 385 | 155 | 1505 |

1602AHS

Saruzófogó szigetelt kábelsarukhoz, standard modell, krómozott, műanyag szárral

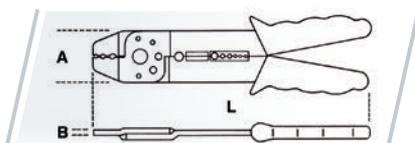

| Modell | mm ² | L mm | A mm | B mm | g |
|-----------|-----------------|------|------|------|-----|
| 016024005 | 0÷6 | 220 | 42 | 4 | 263 |

1760BHS

Univerzális digitális multiméter

VÉGREHAJTHATÓ MÉRÉSEK
 Feszültség DC: 200 mV-2/20/200/1000V
 Feszültség AC: 2-20/200/700V
 Áram DC: 2/20/200 mA-20 A
 Áram AC: 2/200 mA- 20 A
 Ellenállás: 200Ω - 2/20/200 kΩ - 2/20 MΩ
 Kapacitás: 2/20/200 nF - 2/200 μF
 Hőmérséklet: -20° + 1000°C/ -4 °F ~ +2000°F
 Frekvencia: 20kHz
 Tápegység: 1 9V-elem (együtt szállítva)



| Modell | g |
|-----------|-----|
| 017604012 | 670 |

1682HS

Rugalmas skálás vonalzó,
rozsdamentes acélból



| | L mm | H mm | $\pm S$ mm | g |
|-----------|---------|---------|---------------|-------|
| 016824020 | 200 | 13 | 0,5 | 11 |
| 016824030 | 300 | 13 | 0,5 | 16 |

1692HS

Mérőszalag, ütészálló
bimateriál ABS-ház,
acélszalag,
pontossági osztály: II



| | L mm | S mm | g |
|-----------|---------|---------|-------|
| 016924053 | 3 | 16 | 110 |
| 016924055 | 5 | 19 | 200 |

1708HS

Metrikus hézagmérő



| | $\pm S$ mm | $\pm S$ μ | L mm | g |
|-----------|---------------|--------------|---------|-------|
| 017084020 | 0,05÷1 | 0,002÷0,040 | 105 | 100 |

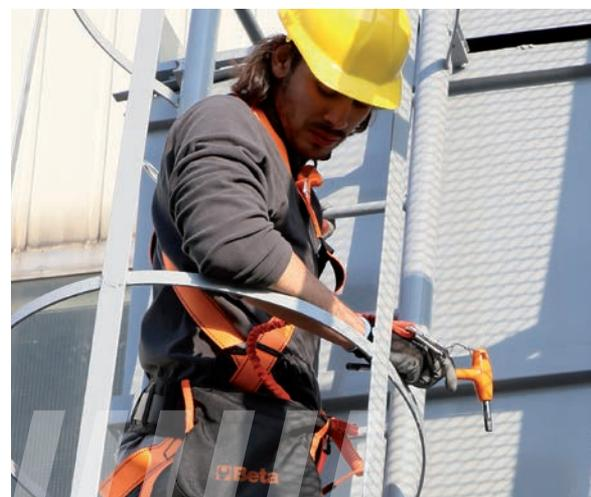

1727HS

Erősített fűrész,
fűrészkeret lakkozott
acélból, fanyéllal,
bimetal fűrészlappal

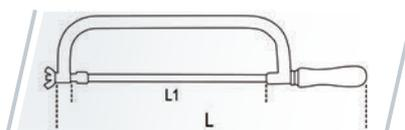
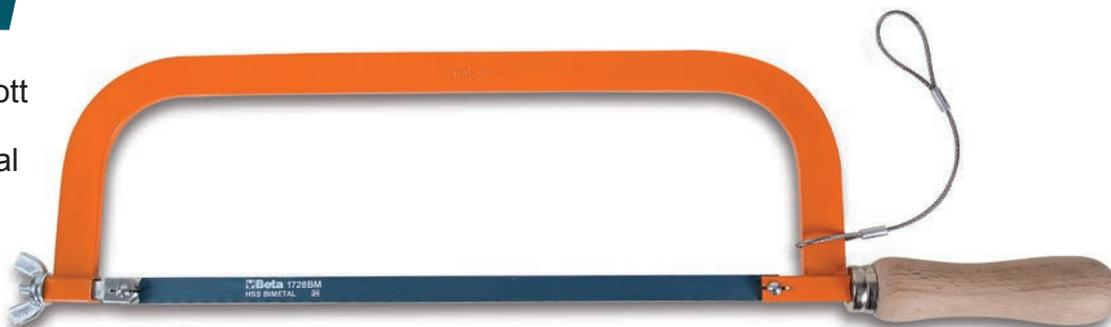

| | L mm | L1 mm | g |
|-----------|---------|----------|-------|
| 017274001 | 515 | 300 | 681 |

1772H-HS

Kés behúzható pengével,
1 tartalék pengével

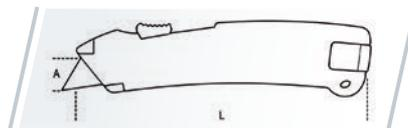

| | L mm | A mm | g |
|-----------|---------|---------|-------|
| 017724029 | 170 | 18 | 681 |

a kiegészítők (tájoló, kulcsok és lemezek) cseréje csak a földön végezhető el

1778SOS-HS

Autós elsősegély kés
ablaktörő kalapács
és biztonsági öv vágó
funkcióval tokban

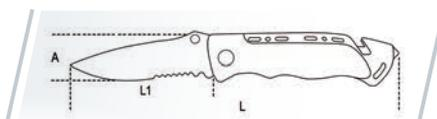

| | L mm | A mm | L1 mm | g |
|-----------|---------|---------|----------|-------|
| 017784080 | 205 | 25 | 85 | 180 |

1743HS

Kábelkötegelő fogó

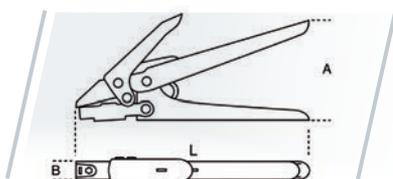

| | L mm | A mm | B mm | g |
|-----------|---------|---------|---------|-------|
| 017434001 | 195 | 85 | 17 | 282 |

1750HS

Karoszsírzó



| | cc | L mm | kg |
|-----------|-----|---------|--------|
| 017504500 | 500 | 380 | 1,3 |

8871

Biztonsági öv, fémcattal és dupla zárral



|  | L cm min+max | g |
|---|-----------------|-----|
| 088710070 | 70-100 | 390 |
| 088710100 | 100-135 | 400 |

8877

Amortizált csatoló heveder

• MAX 2.7 kg



|  | L cm min+max | DxL mm | g |
|---|-----------------|-----------|-----|
| 088770080 | 70-110 | 40x80 | 150 |

8877M

Amortizált csatoló heveder

• Tekeredés megelőző csatlakozóval
• MAX 2.7 kg



|  | L cm min+max | DxL mm | g |
|---|-----------------|-----------|-----|
| 088770510 | 20-140 | 30x60 | 120 |

TARTOZÉKOK





8872A

Merev szíj

• 8871 övhöz



|  | D mm |  g |
|---|---------|--|
| 088720050 | 50 | 42 |

8872AS

A zár húzással nyílik

• 8871 övhöz



|  | D mm |  g |
|---|---------|--|
| 088720525 | 25 | 36 |

8873

Munkaeszköz
hordozó zsák önzáró
és zipzáras zárral

• 8871 övhöz



|  | LxH mm |  g |
|---|-----------|--|
| 088730230 | 230x230 | 250 |



8883

Munkaeszköz hordozó zsák

- 840-es, dörzsölés megelőző nylon
- MAX 20 kg



- A zipzárt a zárvégen blokkoló karabéllyal



- 6 munkaeszköz rögzítő hevederrel
- Belső zsebbel



|  | DxH cm |  kg |
|---|-----------|--|
| 088830030 | 30x40 | 1,1 |

8879

Csuklóvédő húzással nyílik

- MAX 2.7 kg



|  | D mm |  g |
|---|---------|---|
| 088790025 | 30 | 46 |

8880

Merev csatoló heveder

- Tekeredés megelőző csatlakozóval



|  | L cm | D mm |  g |
|---|---------|---------|---|
| 088800030 | 30 | 10 | 60 |





Beta
Height-Safe

Delta Manlift®

PORTATA MAX
265Kg

998011032



Beta
H-SAFE

The logo features a stylized orange icon of a wrench and a screwdriver crossed, followed by the word 'Beta' in a bold, orange, sans-serif font, and 'H-SAFE' in a bold, white, sans-serif font below it.

Beta Utensili S.p.A.
Via Volta 18
20845 Sovico (MB) - Italy
Tel. +39 039.2077.1
Fax +39 039.2010742
www.beta-tools.com